

# FCR PRIMA T2

Extremely fast processing in a compact body streamlines diagnosis



This compact table-top reader unit has outstandingly high-speed processing capability to challenge the common misconception of CR



Processing Capacity  
**73** IPs/hr.

• The above value is for IPs of 18 x 24 cm.

Weight  
**39**kg



**All-in-one workstation**



**FCR PRIMA Console / FCRView**

FCR PRIMA Console and FCRView are all-in-one workstation which meet various radiographic imaging needs. The features include image acquiring, processing, viewing and archiving.

\*FCR PRIMA T2 can also be used with the CR Console and Console Advance.

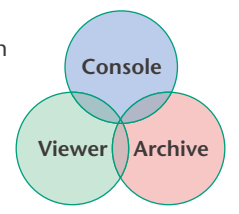

**High-Speed Processing**

FCR PRIMA T2 is a table-top reader unit which boasts a world-class high processing speed of 73 IPs/hour. In the high speed mode (5 pixels/mm), throughput is enhanced almost 70% compared with FCR PRIMA T (only for IPs of 14" x 17" and 14" x 14"). As with all Fujifilm equipment FCR PRIMA T2 is easy to operate. It will help reduce patient waiting time and greatly increase the efficiency of examination workflow.

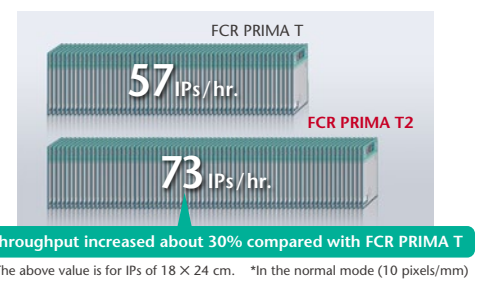

**Space-Saving Design**

FCR PRIMA T2, with its light and compact table top design, can be placed on a desk, shelf or anywhere space is limited. As this is a fully digital reader, neither a darkroom nor automatic processor is required. FCR PRIMA T2 can always be installed in the space formally used by a chemistry based processor.



**Stable High-Quality Images**

Although this is a compact machine its excellent image quality is the same as that produced by the rest of the FCR range. Image Intelligence™, Fujifilm's proprietary image processing technology, enhances image contrast and sharpness, without any deterioration of details. FCR PRIMA T2 supports accurate diagnosis by offering stable and optimized image quality.



<p><b>MFP*</b> Multi-Frequency Processing</p> <p>Enhances FCR images. All diagnostic scopes will be enhanced except for noise. *Optional software</p>	<p><b>FNC</b> Flexible Noise Control</p> <p>Provides a non-grainy image by mainly isolating and suppressing the noise for the signal.</p>	<p><b>GPR</b> Grid Pattern Removal</p> <p>Removes the stationary grid patterns thus preventing Moiré from being generated resulting in easier diagnosis.</p>

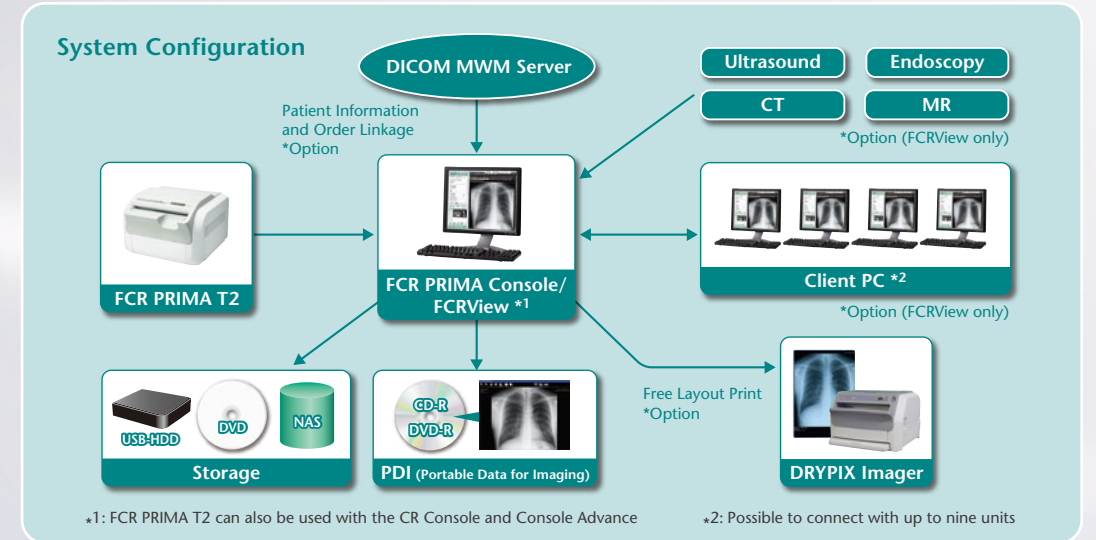

### FCR PRIMA T2 Specifications

Standard Components	FCR PRIMA T2 Image Reader (Model: CR-IR 392)
Applicable Console	FCR PRIMA Console, FCRView, CR Console, Console Advance
Main Connectable Imagers	DRYPIX PRIMA/ Smart/Lite/Plus/4000
Supplies	Imaging Plate ST-VI: 35 × 43 cm (14" × 17"), 35 × 35 cm (14" × 14"), 10" × 12", 8" × 10", 24 × 30 cm, 18 × 24 cm, 15 × 30 cm IP Cassette Type CC: 35 × 43 cm (14" × 17"), 35 × 35 cm (14" × 14"), 10" × 12", 8" × 10", 24 × 30 cm, 18 × 24 cm, 15 × 30 cm
Time Required for IP Feed/Load	Min. 49 sec.
Processing Capacity	Up to 73 IPs/hr.
Reading Specification	10 pixels/mm, 5 pixels/mm
Time to Start on Display	Min. 33 sec.
Time to Print on DRYPIX PRIMA	Approx. 165 sec. (Approx. 155 sec.)* in case of 35 × 43 cm (14" × 17")
Number of Stacker	1
Network	10 Base T/100 Base TX
Dimensions (W × D × H)	560 × 540 × 392 mm (22" × 21" × 15")
Weight	39 kg (86 lbs.)
Power Supply Conditions	Single phase 50-60Hz AC120-240V ±10% 1.9A (max)
Environmental Conditions	Operating Conditions: • Temperature: 15-30°C • Humidity: 15-80%RH (No dew condensation) • Atmospheric pressure: 750-1060 hPa

This equipment is a Class 1 laser product (IEC60825-1:2001).

\*In the high speed mode

# FCR PRIMA T2

Extremely fast processing in a compact body streamlines diagnosis

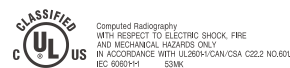
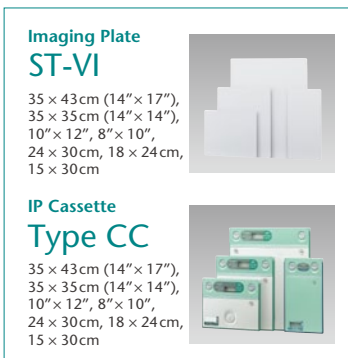
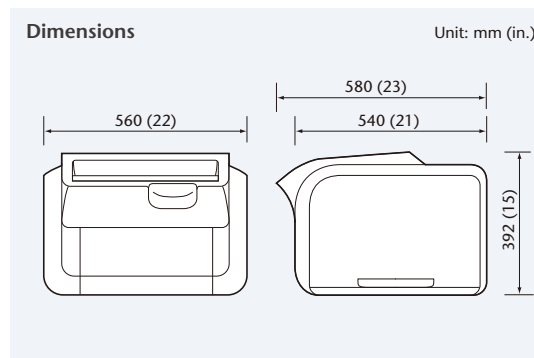
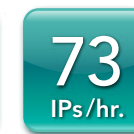

FCR PRIMA T2 (CR-IR 392) CE 0123

Specifications are subject to change without notice.  
All brand names or trademarks are the property of their respective owners.  
In some countries, regulatory approval may be required to import medical devices.  
For the availability of these products, please contact your local sales representatives.