

FCR PRIMA Tm

High-speed image processing tabletop FCR with mammography compatibility



Brand new world's smallest class all-in-one tabletop CR equipped with Mammography Image reading as standard.

Compatible with multiple cassette sizes, covering a wide range of examination

Cassettes of any size can be read. This instrument is applicable to a variety of test settings, ranging from long-view imaging of the entire length of the vertebra or lower limbs to pantomography.



Realizing 50 μm high-definition reading of mammography images

For the first time in the PRIMA series, the model is equipped with a mammography image reading function. With high definition reading and the fastest processing in the tabletop class, this model brings about a seamless workflow to your diagnosis.

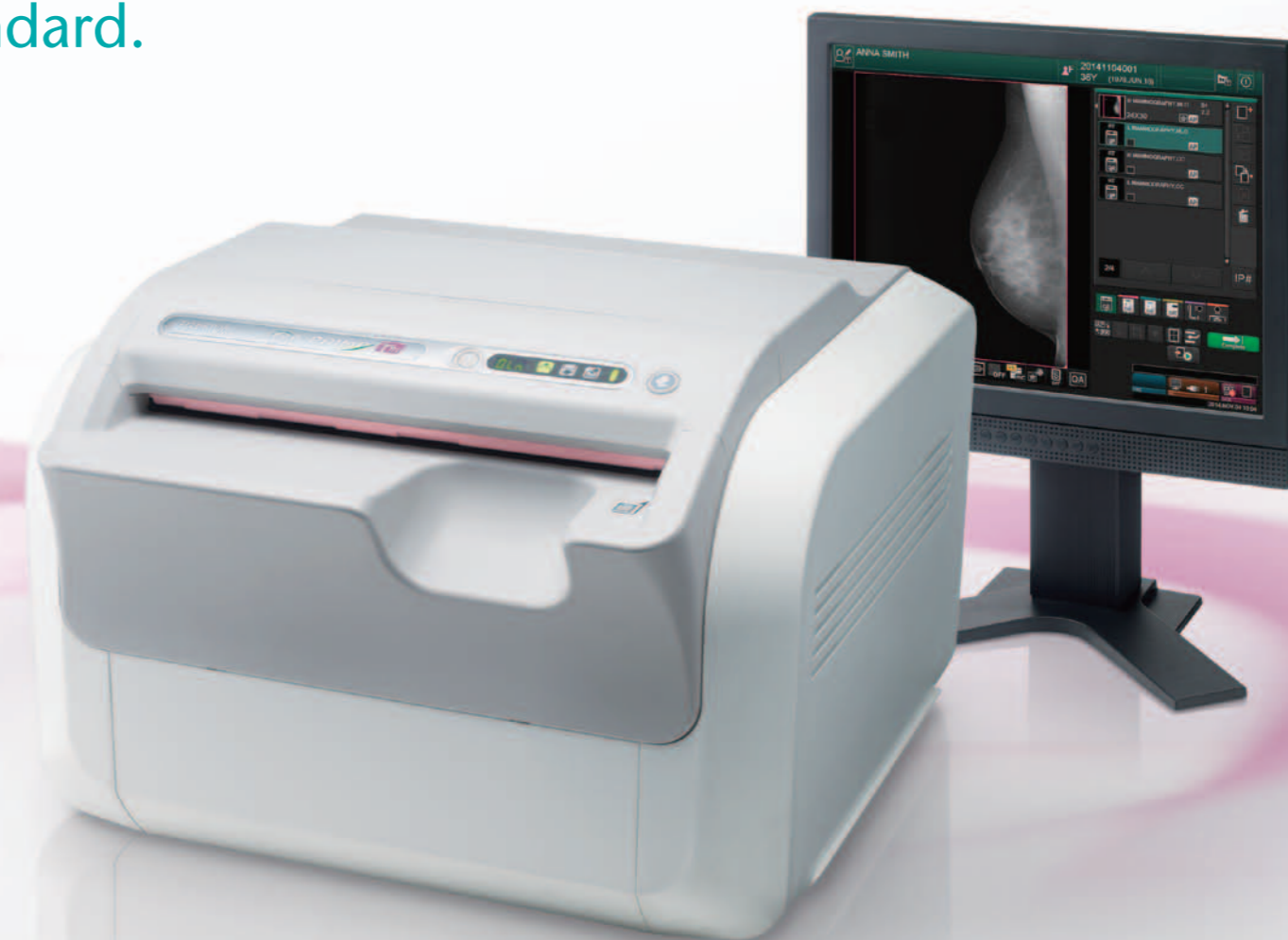
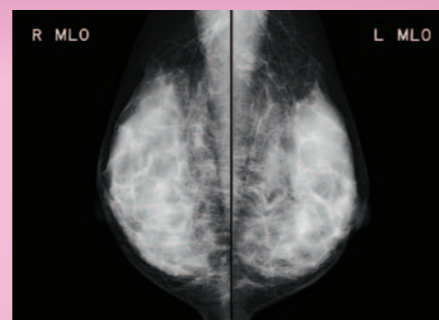

Space-Saving Design

FCR PRIMA Tm, with its light and compact tabletop design, can be placed on a desk, shelf or anywhere space is limited. As this is a fully digital reader, neither a darkroom nor automatic processor is required.

0.30 m²

footprint

54 × 56 cm

size

39 kg

weight



High-Speed Processing

With the highest processing speed in its class, this model can process 73 images per hour. In addition, 40 mammography images can be processed within an hour, allowing smooth image reading.



Approx. 33 sec.



73 IPs/hr.

Type CC (18 × 24 cm)

40 IPs/hr.

Type CH for Mammography (18 × 24 cm)

High-Quality Mammography Images

Fujifilm's Image Intelligence™ technology automatically enables stable and optimized high-quality images.



Multi-Frequency Processing

*Optional software

Enhances FCR images. All diagnostic scopes will be enhanced except for noise.

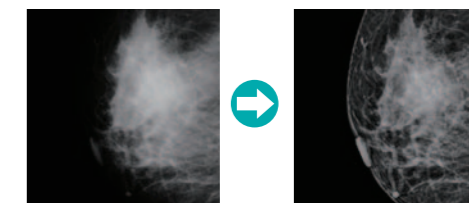

Dust-proof Mechanism

The insertion slot of the cassette is equipped with functions that prevent the entry of dust and automatically clean the inside of the instrument to remain dust-free.

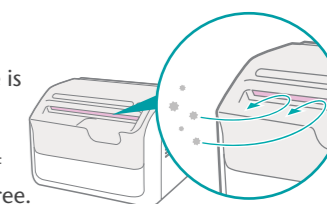

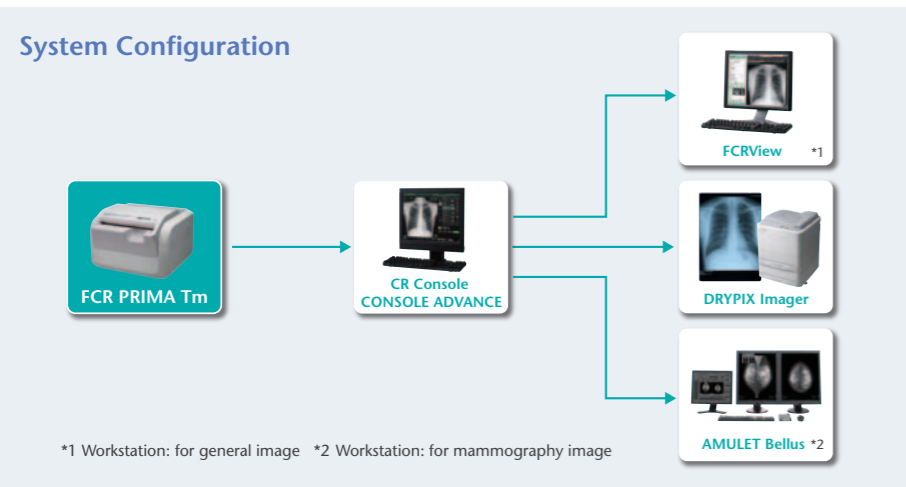

FCR PRIMA Tm Specifications

Standard Components	FCR PRIMA Tm (Model: CR-IR 392)	
Applicable Console	CR Console, Console Advance	
Main Connectable Imagers	DRYPIX PRIMA, DRYPIX 4000, DRYPIX 5000, DRYPIX 7000, DRYPIX Plus, DRYPIX Smart	
Supplies	Imaging Plate	ST-VI (standard type) 35 × 43 cm (14" × 17"), 35 × 35 cm (14" × 14"), 10" × 12", 8" × 10", 24 × 30 cm, 18 × 24 cm, 15 × 30 cm HR-VI (high-resolution type) 24 × 30 cm, 18 × 24 cm
	IP Cassette	Type CC 35 × 43 cm (14" × 17"), 35 × 35 cm (14" × 14"), 10" × 12", 8" × 10", 24 × 30 cm, 18 × 24 cm, 15 × 30 cm Type CH 24 × 30 cm, 18 × 24 cm Type LC 35.4 × 124.5 cm, 35.4 × 101.7 cm, 35.4 × 83.0 cm, 25.2 × 58.0 cm, 24.0 × 57.0 cm
Time Required for IP Feed/Load	Min. 49 sec.	
Processing Capacity	Up to 73 IPs/hr.	
Reading Specification	10 pixels/mm, 5 pixels/mm, 20 pixels/mm	
Time to Start on Display	Min. 33 sec.	
Time to Print on DRYPIX Smart	Approx. 165 sec. (Approx. 155 sec.)* in case of 35 × 43 cm (14" × 17")	
Number of Stacker	1	
Network	10 Base T/100 Base TX	
Dimensions (W × D × H)	560 × 540 × 392 mm (22" × 21" × 15")	
Weight	39 kg (86 lbs.)	
Power Supply Conditions	Single phase 50-60 Hz AC120-240V ±10% 1.9A (max)	
Environmental Conditions	Operating Conditions: • Temperature: 15-30°C • Humidity: 15-80%RH (No dew condensation) • Atmospheric pressure: 750-1060hPa	

This equipment is a Class 1 laser product (IEC60825-1:2001).

*In the high speed mode

Dimensions

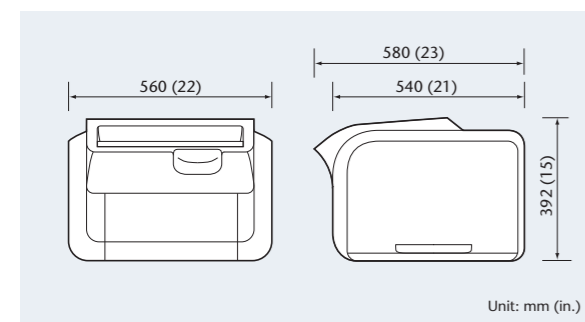

IP Cassette



• **Compatible with CR Console/Console Advance**

The CR Console/Console Advance optimizes your mammography examinations with its advanced design and features. Correspondence to Fujifilm Mammography QC Program with 1Shot Phantom.

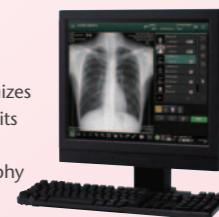

• **Compatible with Fujifilm Mammography QC Program**

Fujifilm Mammography QC Program is a dedicated quality control program applicable to FUJIFILM digital mammography system. This program enables the system to keep a stable image quality for both screening and diagnosis.



Specifications are subject to change without notice. All brand names or trademarks are the property of their respective owners. In some countries, regulatory approval may be required to import medical devices. For the availability of these products, please contact your local sales representatives.



FCR PRIMA Tm

High-speed image processing tabletop FCR with mammography compatibility

